

DRIVE CLIQ CABLE

Specification: 6FX8002-2DC10-1CA5

DRIVE-CLiQ signal cable for SINAMICS S120 and motors with DC 24 V wires

Male straight – male straight

DRIVE-CLiQ IP20 – DRIVE-CLiQ IP67, 10-pole

Further cable lengths on request.

The resistance to aggressive media should be individually tested for your application. Further details on request.

[Link to Product](#)

Illustration

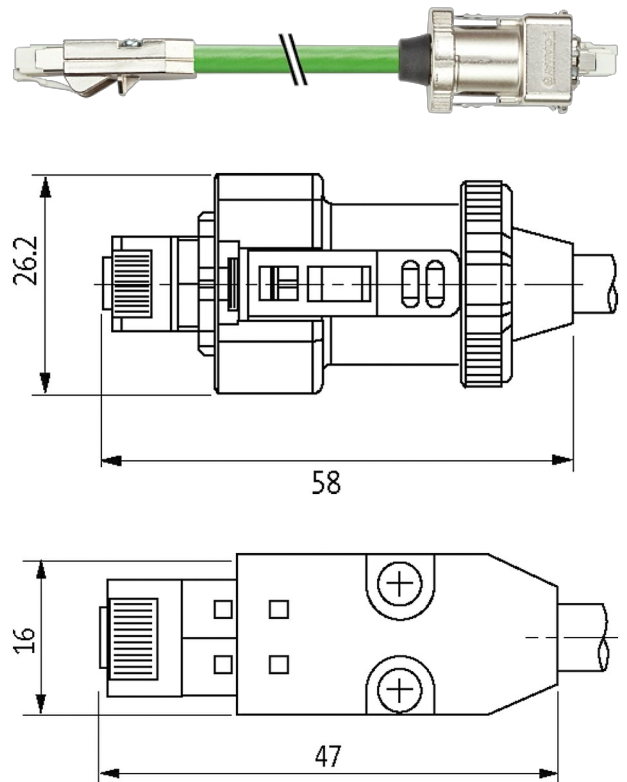

Product may differ from Image

Form

Form SS051

General data

Pollution Degree	3
Mounting method	pluggable
Temperature range	-20...+80 °C, depending on cable quality

Cables

Cable number	880
No./diameter of wires	2 × 2 × 0.20 + 1 × 2 × 0.38
Wire isolation	PO (gnye, pkbl, rdbk)
C-track properties	5 Mio.
Jacket Color	green
Material (jacket)	PUR (UL/CSA)

Outer Ø	6.9 mm ±5%
Bend radius (moving)	10× outer Ø
Temperature range (fixed)	-20...+80 °C
Temperature range (mobile)	-20...+60 °C
Shield	yes
	min. 85%
Material (jacket)	PUR
Torsion stress	±30 °/m
Specification	MC800+ (6FX8008-1DC00)

Technical Data

Operating voltage	max. 30 V AC/DC
Rated surge voltage	0.5 kV
Operating current	max. 1.76 A
Material group	IEC 60664-1, category II
Locking of ports	DRIVE-CLiQ-System
Protection	IP20/IP67

Commercial data

country of origin	DE
customs tariff number	85444210
EAN	4048879705714
eClass	27061801
Packaging unit	1

Sketch

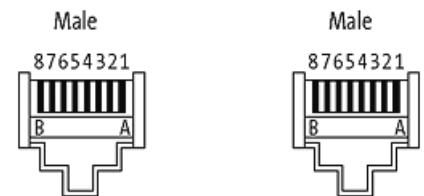

Product may differ from Image